

Practical Calibration Applications

Dean Ripple
Process Sensing Group
NIST, Gaithersburg

IFTPS Annual Meeting, March 2, 2010

- Reference standards
- Overview of calibration process
- Uncertainties
- Closer look at PRT calibration
- Measurement assurance

Material in this talk compiled from:

1. D. Ripple, "Thermometry Issues in Destruction Kinetics Measurement," NISTIR 7602 (2009)
2. D. Ripple, "Cold Chain Storage of Vaccines: A Brief Introduction to Thermometry," NISTIR 7522 (2008).
3. G. Strouse et al., "A New NIST Automated Calibration System for Industrial-Grade Platinum Resistance Thermometers," NISTIR 6225 (1998).

The Calibration Process

What is Calibration?

UUT = unit under test

Calibration process relates the indications of UUT to the temperature values of a reference standard thermometer.

Indications could be in ohms (resistance thermometer), volts (thermocouple), or temperature (sensor + readout).

Calibration process has associated uncertainties.

Calibration requires:

- a reference standard in good health
- a mechanism to achieve thermal equilibrium between the standard and the UUT
- documented uncertainties & procedures
- readouts for any thermometers used

Reference Standards

Thermometers

For the temperature range of interest, typical standard will be a calibrated platinum resistance thermometer—

- Standard Platinum Resistance Thermometer (SPRT) has best uncertainty, but is very susceptible to mechanical shock
- Higher grades of Industrial PRTs (IPRT, RTD) will work fine

OR

Fixed Points

Thermometers may be calibrated at a series of “fixed points”—reproducible melting or freezing points of pure materials

- Ice melting point (0 °C), water triple point (0.01 °C), gallium melting point (≈ 30 °C), indium freezing point (≈ 157 °C),
- Thermometers may be checked at the ice melting point or the steam point.

Examples of Reference Standards

Cross section of a metal
freezing-point cell

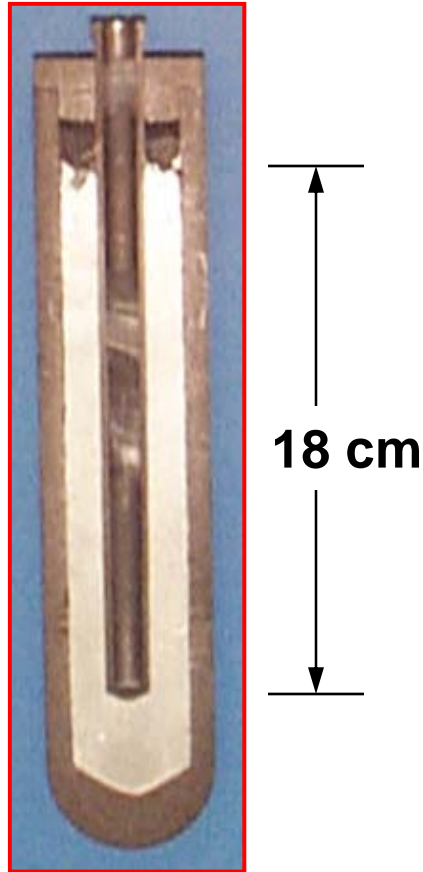

SPRT Coil

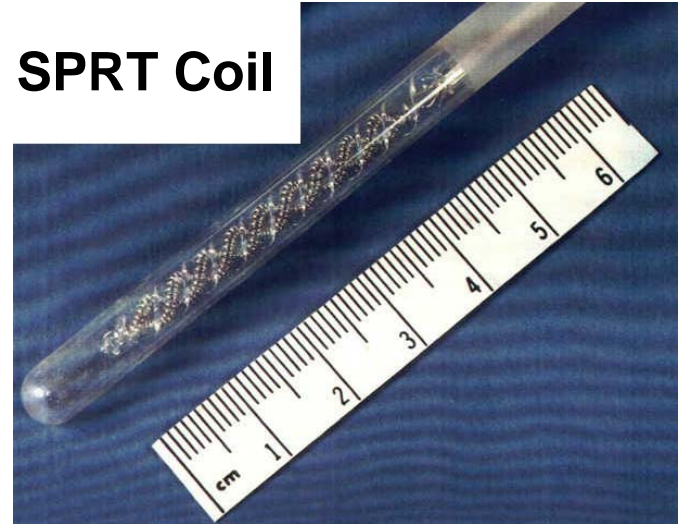

Attainable uncertainties with SPRTs calibrated at fixed points ≈ 0.001 °C, but SPRT is very susceptible to mechanical shock.

Comparison in a Stirred Liquid Bath

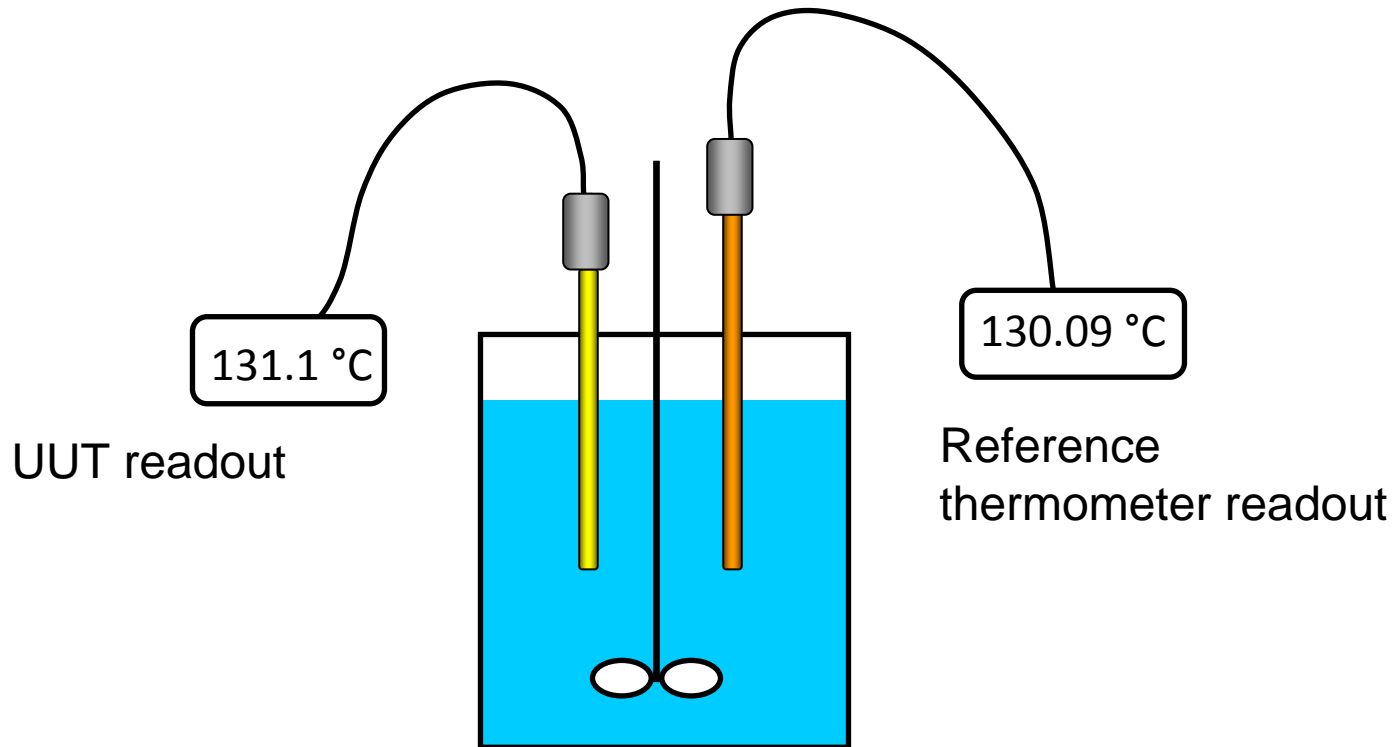

- Unit under test is calibrated against a previously calibrated reference thermometer.
- Many suppliers of commercial baths
- Water for 1 to $90\text{ }^{\circ}\text{C}$; silicone oils up to approximately $200\text{ }^{\circ}\text{C}$

Stirred Liquid Baths: Tips for Success

1. **Working area of bath should be deep enough** so sensors can be immersed sufficiently for full thermal equilibrium with fluid.
2. The control thermometer of the bath is not used for the calibration; in fact, no calibration is needed on the control thermometer.
3. Bath temperature does not have to be set to exact temperature of calibration point; ± 1 °C (± 2 °F is fine).
4. Bath needs to be stable over the time for sensors to equilibrate with the bath liquid—approximately 10 min.
5. Bath needs to be uniform over the maximum distance between UUTs and reference thermometer. (OK to have multiple UUTs within working zone)
6. Silicone oil is hard to remove from sensors—if probe cannot go into oil, use a close-fitting glass or stainless-steel tube with one closed end.

Comparison in a Dry-Block Calibrator

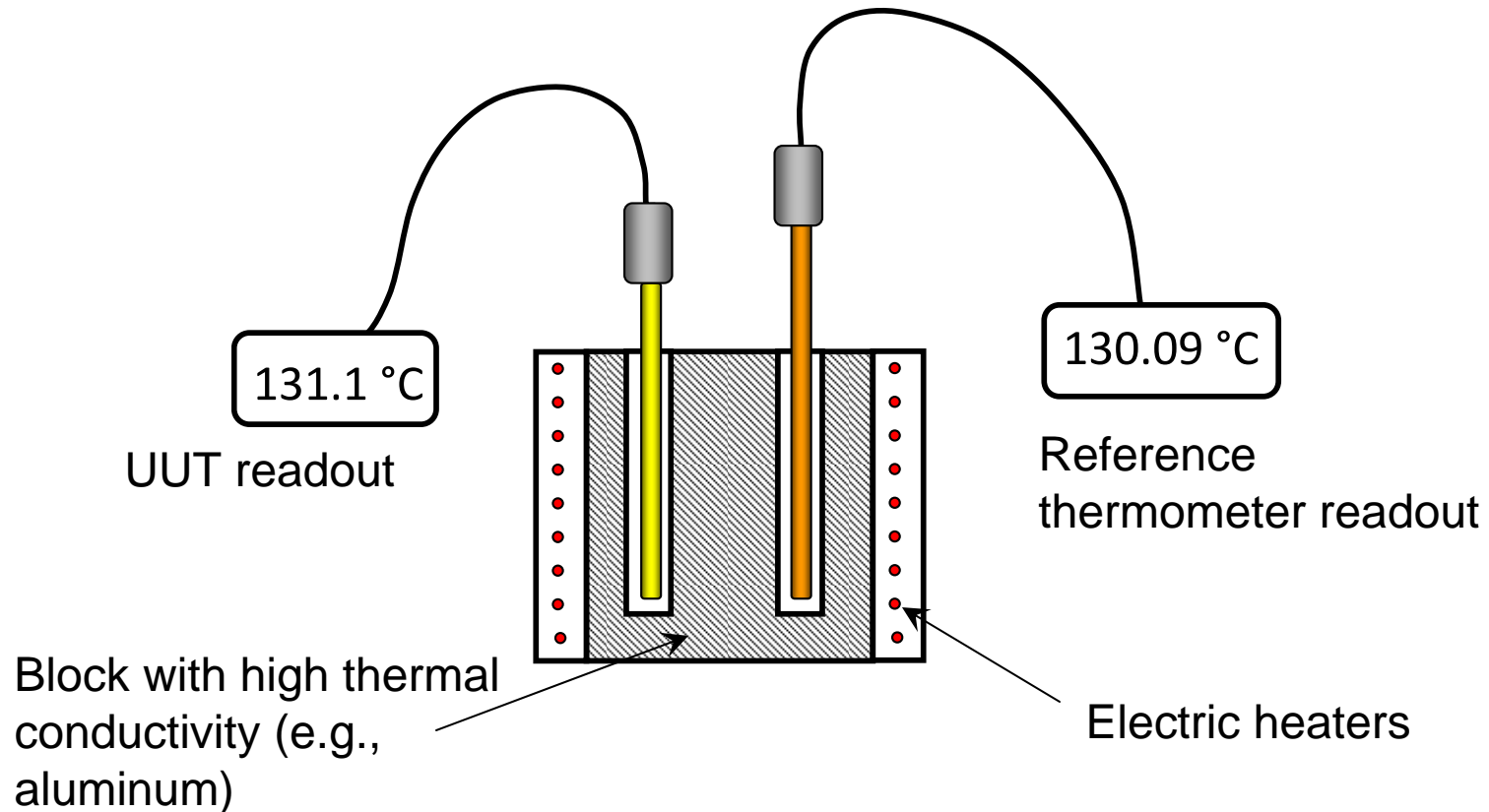

- Unit under test is calibrated against a previously calibrated reference thermometer.
- Many suppliers of dry-block calibrators
- Be sure block has sufficient depth & uniformity

Dry-block comparators: Tips for Success

1. **Temperature uniformity is more difficult to achieve with a dry-block calibrator than with a stirred-liquid bath.** Read manufacturer's literature carefully, and check by calibrating probes at multiple immersion depths.
2. **Holes for probes should be a close slip fit**—large air gaps will lead to large errors.
3. The control thermometer of the block is not used for the calibration; in fact, no calibration is needed on the control thermometer.
4. Block temperature does not have to be set to exact temperature of calibration point; ± 1 °C (± 2 °F is fine).
5. Block needs to be stable over the time for sensors to equilibrate with the block—approximately 10 min.

Calibration at a Fixed Point: Ice Melting Point

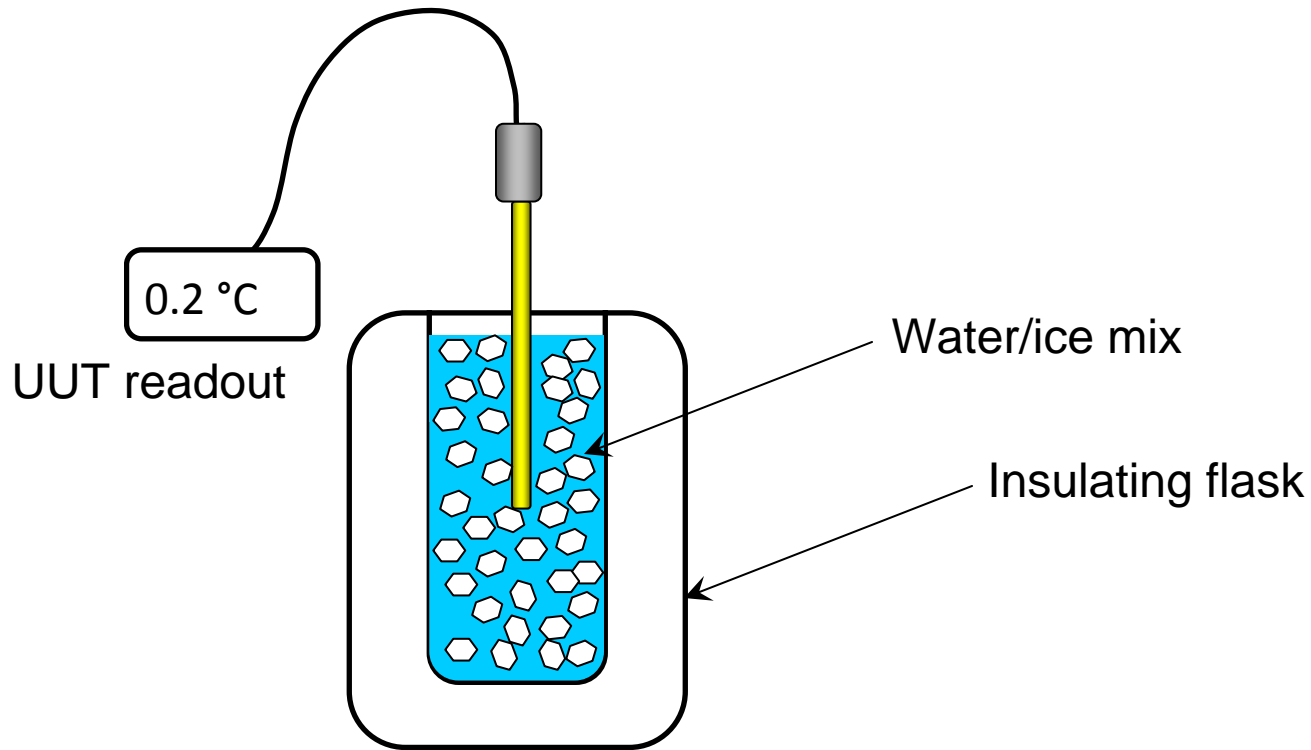

- Temperature of melting ice is 0 °C (32 °F), to within 0.002 °C (highest quality ice bath) to 0.02 °C (bath made with supermarket-grade water).
- The temperature is fixed at the water-ice interfaces.
- General requirement: be sure flask is full top-to-bottom with ice/water mix.

Ice Bath: Tips for Success

1. **No reference thermometer is needed!** A properly made ice bath will have a reproducible temperature.
2. **Ice should be made from purified water and have a cube size not more than 1 cm** (size of a gumdrop or smaller).
3. **Do not poke holes in firm ice with the sensor**—use a clean rod
4. The flask type doesn't matter: a Dewar flask or insulated drink container
5. Water should be distilled water, or purified by deionization or reverse osmosis.
6. Shaved ice + best distilled water gives an uncertainty of 0.002 °C
7. 1 cm ice blocks + supermarket-grade purified water has an uncertainty of 0.02 °C
8. Be sure the sensor tip is located at least 2 cm (1 in.) from the walls of the flask
9. Wait 10 minutes for probe to come to equilibrium temperature

Calibration at a Fixed Point: Steam Point

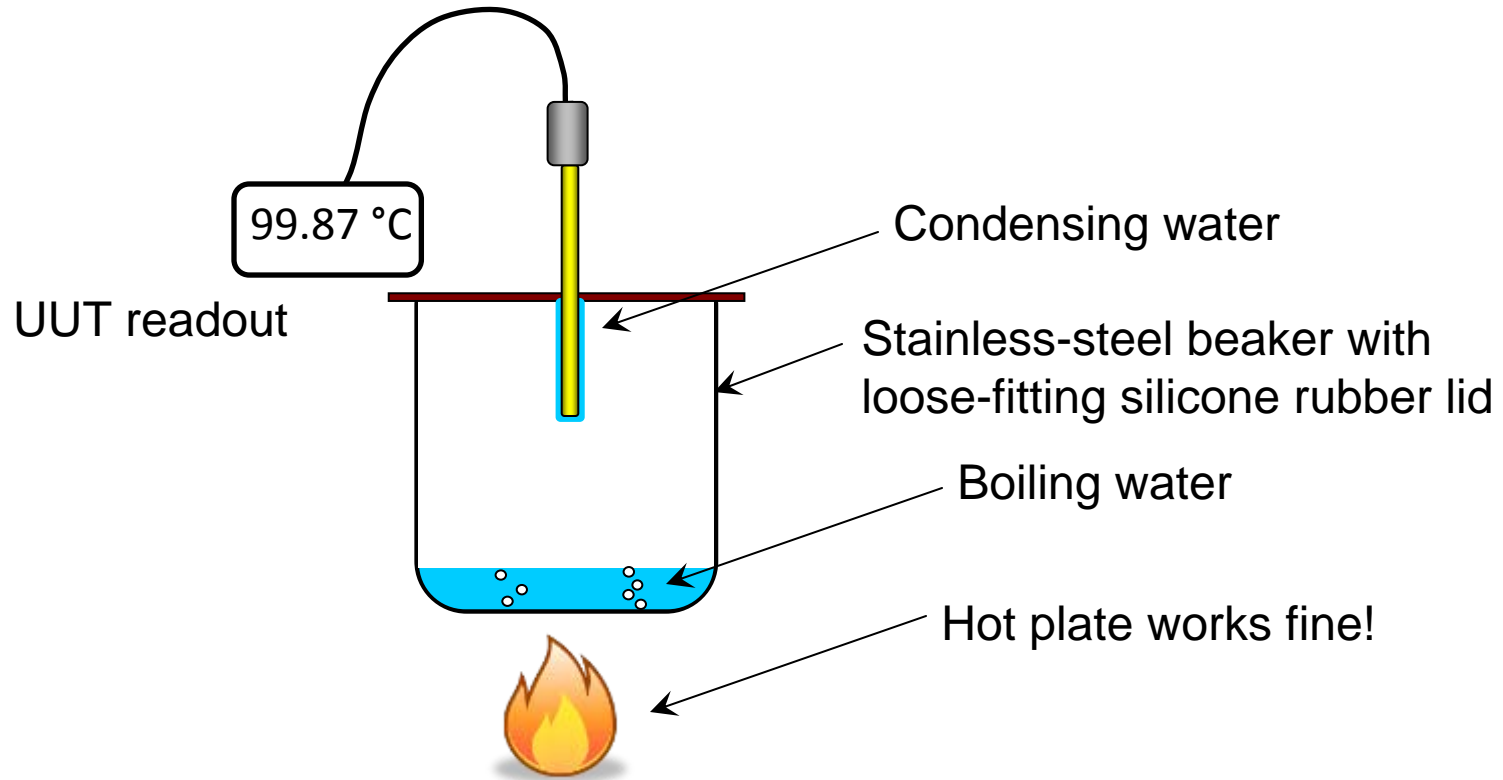

Temperature of condensing steam depends on atmospheric pressure and elevation!

The temperature is fixed at the water-vapor interface of the water condensing on the thermometer.

General requirement: Do NOT place the thermometer in the boiling water. DO place it with the tip 2 cm (1 in.) above the top of the water.

Details: [contact dean.ripple@nist.gov](mailto:dean.ripple@nist.gov)

Typical Measurement Uncertainty Budget: Comparison Calibration

Component	Method of evaluation
Reference thermometer uncertainty	Manufacturer, calibration report, or tolerance
Drift of reference thermometer since last calibration	Literature, manufacturer, recalibration, or in situ check
Readout uncertainty (UUT & reference)	Manufacturer or independent evaluation
Temperature stability	Record bath temperature vs. time and take standard deviation of readings
Temperature non-uniformity	Move probe or use multiple probes
UUT repeatability	Manufacturer's literature or repeatability at ice point or cal. point

Note that only the first item is included in the calibration certificate of the reference thermometer

Quick Guide to Uncertainty Terminology

- An uncertainty is a statistical measure of how likely the result of a measurement agrees with the true answer.
- Uncertainty at 68 % confidence (“standard uncertainty”) is denoted with lower case u . The difference between the true answer and the measured value will be less than $\pm u$, 68 % of the time.
- For higher confidence limits, u is multiplied by a coverage factor k to obtain the “expanded uncertainty” $U = k u$
- The default for calibration certificates is $k=2$, which for normally distributed uncertainties corresponds to a 95 % confidence limit.
- When there are multiple uncertainty components, the combined uncertainty u_c is obtained by adding the components in quadrature:

$$u_c = \sqrt{u_1^2 + u_2^2 + \cdots + u_n^2}$$

Uncertainty, continued

- If we only know that an error is between two limits, divide limit by $\sqrt{3}$ to obtain u value
e.g., tolerance on a readout is ± 0.1 °C gives $u = (0.1 \text{ °C}) / \sqrt{3} = 0.06$ °C
- When combining uncertainties in quadrature, the largest components dominate
e.g., uncertainties of 1 °C and 0.3 °C summed in quadrature equal only 1.04 °C

Recipe:

1. Collect information for each term
2. Convert \pm tolerances into u by dividing by $\sqrt{3}$
3. Convert any expanded uncertainties into u by dividing by 2
4. Add all components in quadrature to obtain combined uncertainty
5. Multiply by 2 to obtain the expanded uncertainty for the calibration

Comparison Bath Spatial Non-uniformity

Map of locations
measured in
volume of oil bath

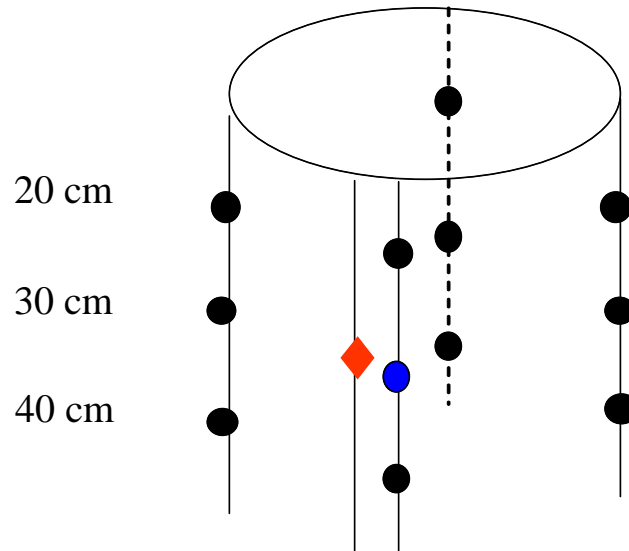

Two thermometers

- Reference thermometer position is fixed at 30 cm (red diamond)
- Second thermometer (circles) is measured at a three depths at four equally-spaced positions.
- Correct all readings of secondary thermometer by difference observed when check thermometer (blue circle) is located close to reference thermometer.
- Calculate difference between reference and corrected check thermometer readings for each position

Maximum difference gives limit for Spatial Non-uniformity Uncertainty

Adding up measurement uncertainties

Table of uncertainties

Calibration of reference thermometer	0.02 °C
Drift of reference thermometer since last cal.	0.01 °C
Readout for reference thermometer	0.002 °C
Bath uniformity	0.015 °C
Bath stability over 10 min	0.010 °C
Repeatability of UUT from multiple ice points	0.04 °C

Root-sum-square (used by metrologists) =

$$u_c = [(0.02)^2 + (0.01)^2 + (0.002)^2 + \dots]^{1/2} = 0.049 \text{ °C} = \text{likely error}$$

Multiply by 2 to get the expanded uncertainty $U = 0.099 \text{ °C}$

PRT Uncertainties in Actual Use

Uncertainties are for the calibration of the IPRT at the measured temperatures – not in the use of the IPRT

We've already accounted for short-term repeatability of UUT (not uniform practice)

- We need to add in an allowance for drift of the PRT with time
- May need to add in components for drift with change in environmental conditions, or for use of a less accurate readout

Example of Uncertainty in Use

Calibration uncertainty

$$u = 0.049 \text{ } ^\circ\text{C}$$

Readout has additional tolerance of 0.02 °C for operating condition variations.

$$u = (0.02 \text{ } ^\circ\text{C})/\sqrt{3} = 0.012 \text{ } ^\circ\text{C}$$

Experience with instruments shows 95 % of instruments drift < 0.06 °C between calibrations

$$u = (0.06 \text{ } ^\circ\text{C})/2 = 0.03 \text{ } ^\circ\text{C}$$

Total in quadrature

$$u_c = \left[(0.049 \text{ } ^\circ\text{C})^2 + (0.012 \text{ } ^\circ\text{C})^2 + (0.03 \text{ } ^\circ\text{C})^2 \right]^{1/2} \\ = 0.059 \text{ } ^\circ\text{C}$$

Expanded uncertainty for actual use

$$U = 2u_c = 2(0.059 \text{ } ^\circ\text{C}) = 0.12 \text{ } ^\circ\text{C}$$

IPRT Measurement System

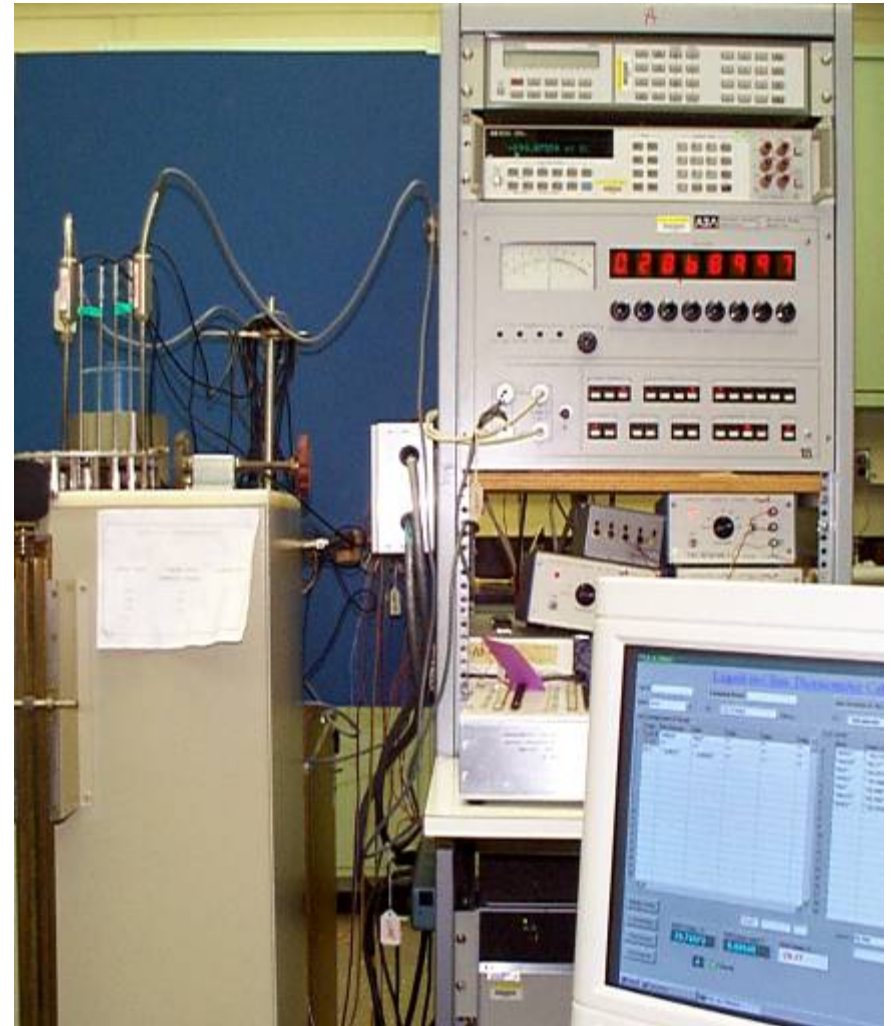
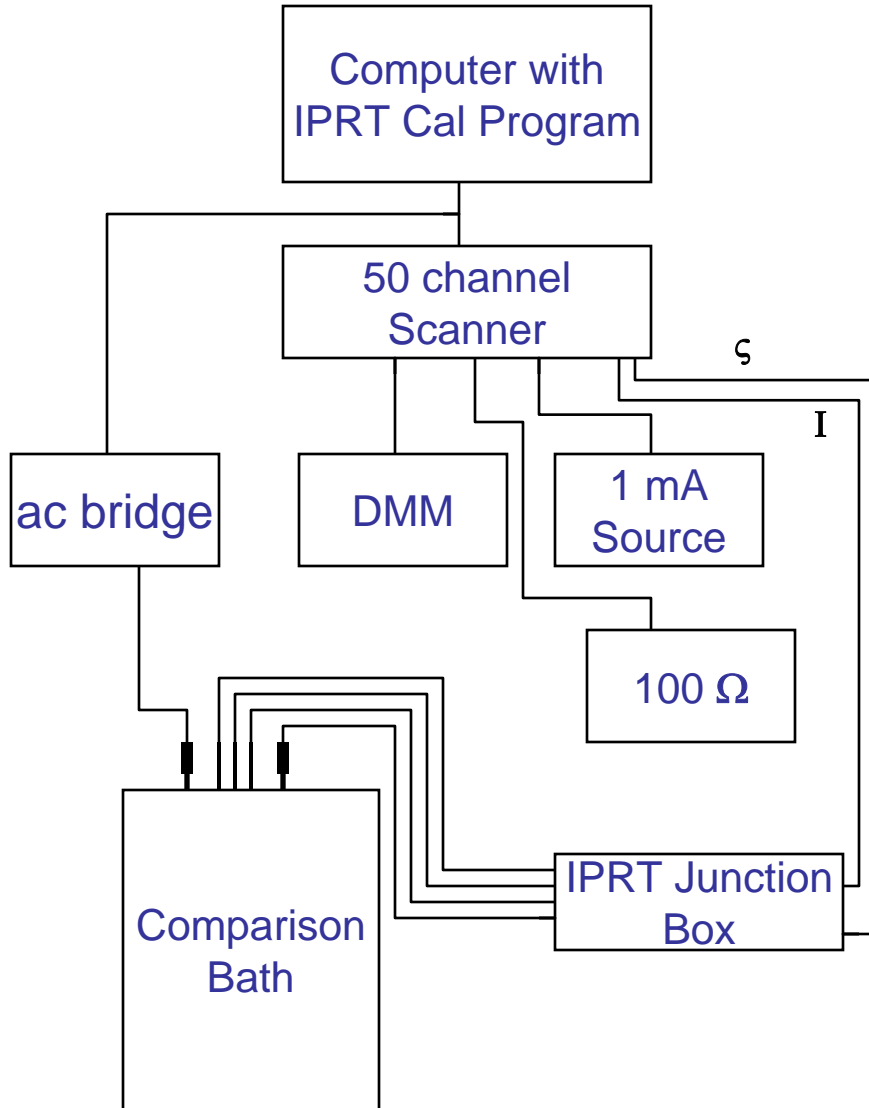

IPRT Comparison Calibration Measurement Overview

Metal-sheathed

- Test of insulation resistance: 50 V dc, $R(22\text{ °C}) > 100\text{ M}\Omega$

Wiring (3-wire or 4-wire) for calibration should match usage.

Insert probe in glass tube if not compatible with bath liquid

Calibrate at the same current as used, typically 1 mA

**High temperature to low temperature measurements,
bracketed by 0 °C**

- e.g. 0 °C, 200 °C, 100 °C, 0 °C

Stability at 0 °C evaluated

**Immersion test at highest and lowest temperature performed
for new design**

IPRT Comparison Measurement Sequence

Sequence for comparison temperature measurement

- | | |
|-------------------|--------------------|
| 1) reference SPRT | 7) check PRT |
| 2) UUT1 | 8) UUT3 |
| 3) UUT2 | 9) UUT2 |
| 4) UUT3 | 10) UUT1 |
| 5) check PRT | 11) reference SPRT |
| 6) reference SPRT | |

- Comparison bath temperature determined from average of three SPRT readings
- Drift in bath temperature during measurements is calculated
- Repeat if bath/block not stable during cycle

Commercial Measurement Equipment & Software

Digital Readout

- Accepts ASTM E1137 or ITS-90 coefficients
- Multiple IPRTs possible with scanner
- Uncertainty is a function of cost, resolution, stability, and calculation of temperature

Multimeter

- 6.5 to 8.5 digit
- Measure using 2-wire or 4-wire ohm mode (check excitation current)
- May accept ASTM E1137 or ITS-90 coefficients
- Uncertainty is a function of cost, resolution, stability, method of use, excitation current, and in some cases the calculation of temperature

Separate software available from various thermometer vendors

Important to validate the calculation of temperature of either the digital readout, multimeter, or software

Sources of Errors When Using IPRTs

Stability

- Repeatability at 0 °C or 0.01 °C

Immersion

- Check immersion characteristics of IPRT on insertion in thermal environment
- Critical for Dry Well Block Calibrators with only 6" immersion depth

Insulation Resistance

- $R(22\text{ °C}) > 100\text{ M}\Omega$ at 50 V dc is equivalent to 0.1 m°C error
- May degrade with shock or high-moisture environments

Mechanical Shock and Vibration

- Vibration or dropping the IPRT will cause the IPRT to drift or fail

Hysteresis

- Measurement of temperature with increasing temperature may be different than measurement of temperature with decreasing temperature

Self Heating

- Calibration and measurement current must be the same (nominally 1 mA)
- Thermal contact with temperature of interest is important

Immersion Test of an IPRT

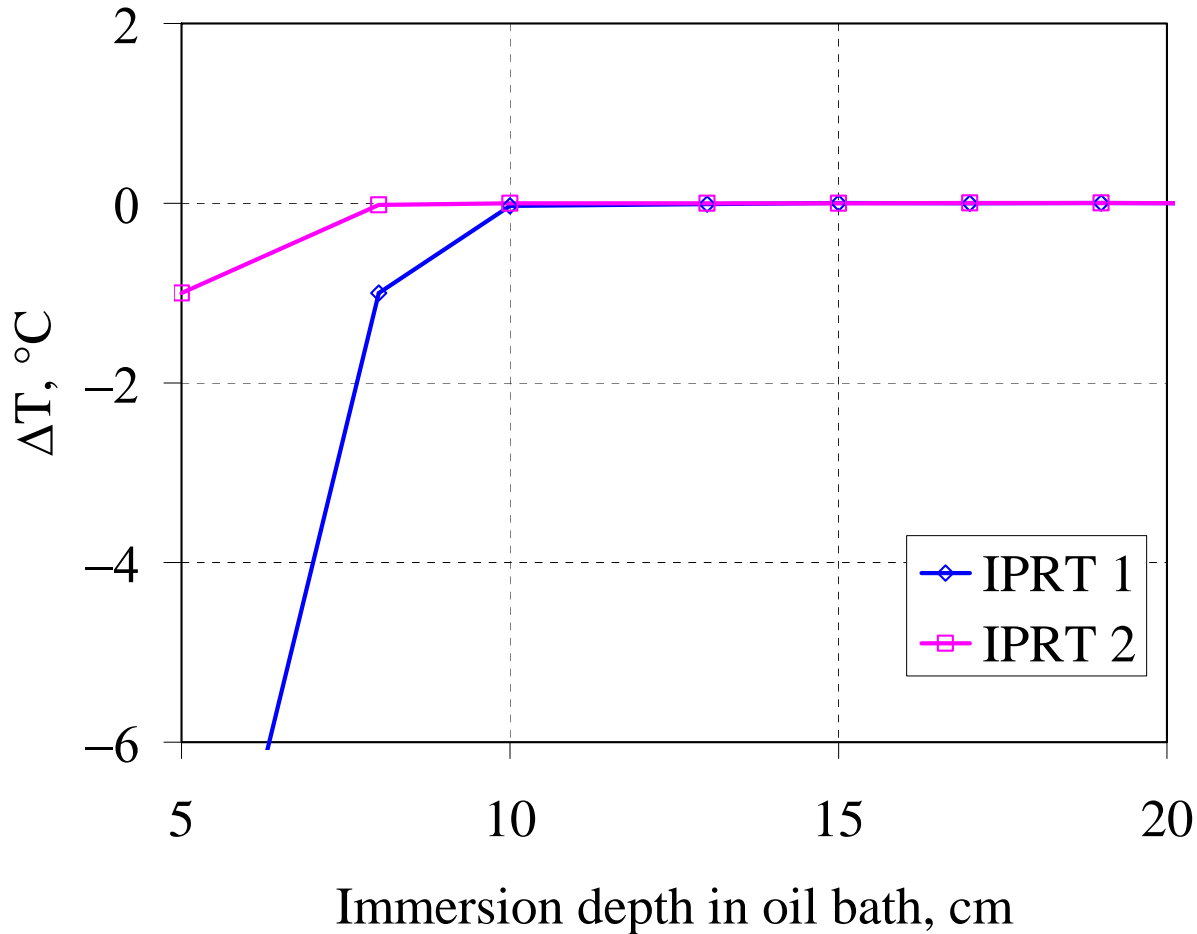

Immersion Profile of IPRT on Insertion

- Different designs will exhibit different immersion characteristics

Water Soak End Seal Test (ASTM E644)

Designed to test the integrity of the thermometer end seal

- Non-destructive to an intact end seal



Measure Insulation Resistance

ASTM spec: 100 M Ω at 50 V, 25 °C \pm 5 °C



Heat thermometer at 80 °C for 1 h

- creation of a pressure differential



Soak thermometer for 1 h

- <15 s transfer from furnace
- end seal is immersed



Measure Insulation Resistance

ASTM spec: 100 M Ω at 50 V, 25 °C \pm 5 °C

Shopping for a calibration laboratory

Do you want units adjusted?

If yes, then consider:

- experience of facility with your brand of unit (esp. electronic)
- does cal. report give as-received and as-adjusted data?

Look for:

- stated traceability to NIST
- documented uncertainty
- accreditation of laboratory to ISO 17025 (not mandatory, but a sign of some level of proficiency)
- good past history

Measurement Assurance

Six examples:

1. Measurements at the ice point/steam point
2. Use of a check standard (second redundant thermometer)
3. Evaluation of historical calibration results
4. On-site check in a portable dry-block or oil bath
5. Comparison of monitor thermometer with setting of control thermometer
6. Redundant thermometers (say one PRT and one thermocouple)

You don't have to do all six, but you should have some system in place.

Check Standards

- Thermometer that is kept in the laboratory and calibrated along with UUTs
- Examining the calibration results plotted vs. time will reveal problems with calibration process

Plotting the data from ice-point readings

Monitor readings at the ice point for sudden changes or for values unacceptably far from 0 °C

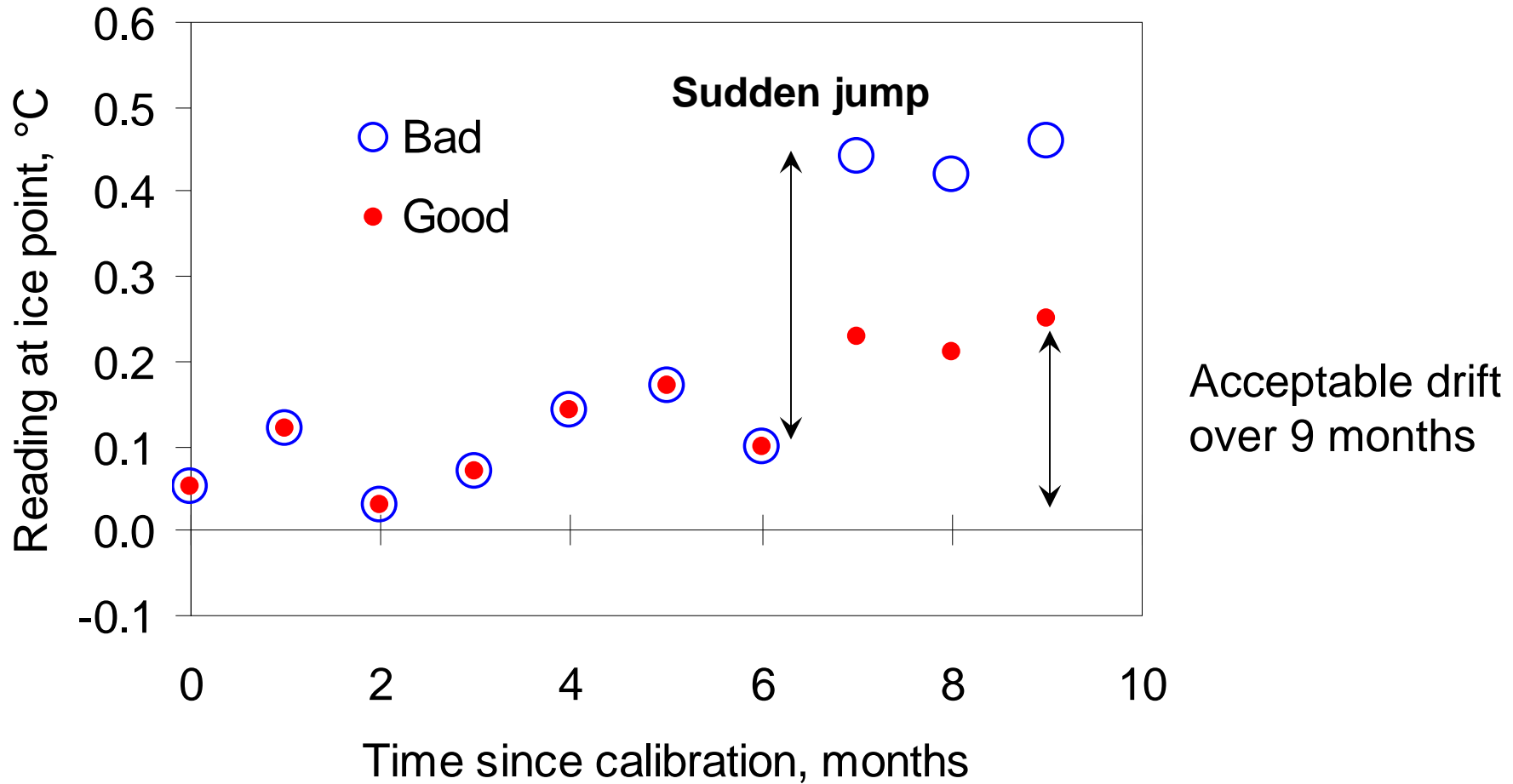

Same principle for steam point or on-site comparison checks!

Example: Thermometer readout dropped

We DO NOT calibrate the reference thermometer with the check thermometer.

We DO use the change in $T_{\text{ref}} - T_{\text{check}}$ as an indicator of potential problems

Unexpected change tells us to have reference checked and recalibrated

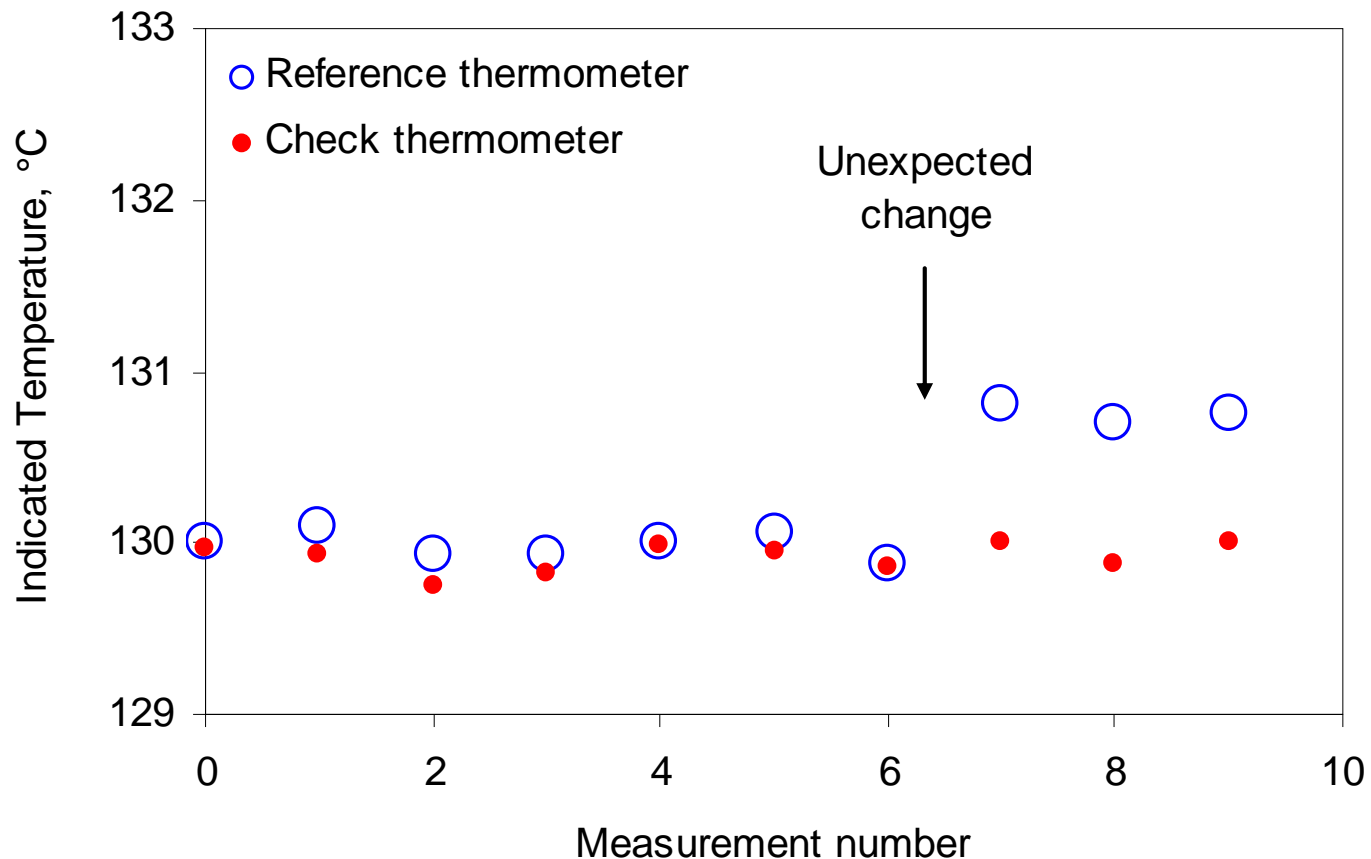

Example: Slow divergence of reference & check thermometers

We DO NOT calibrate the reference thermometer with the check thermometer.

When magnitude of $T_{\text{ref}} - T_{\text{check}}$ nears allowance for drift of the reference, we recalibrate reference thermometer

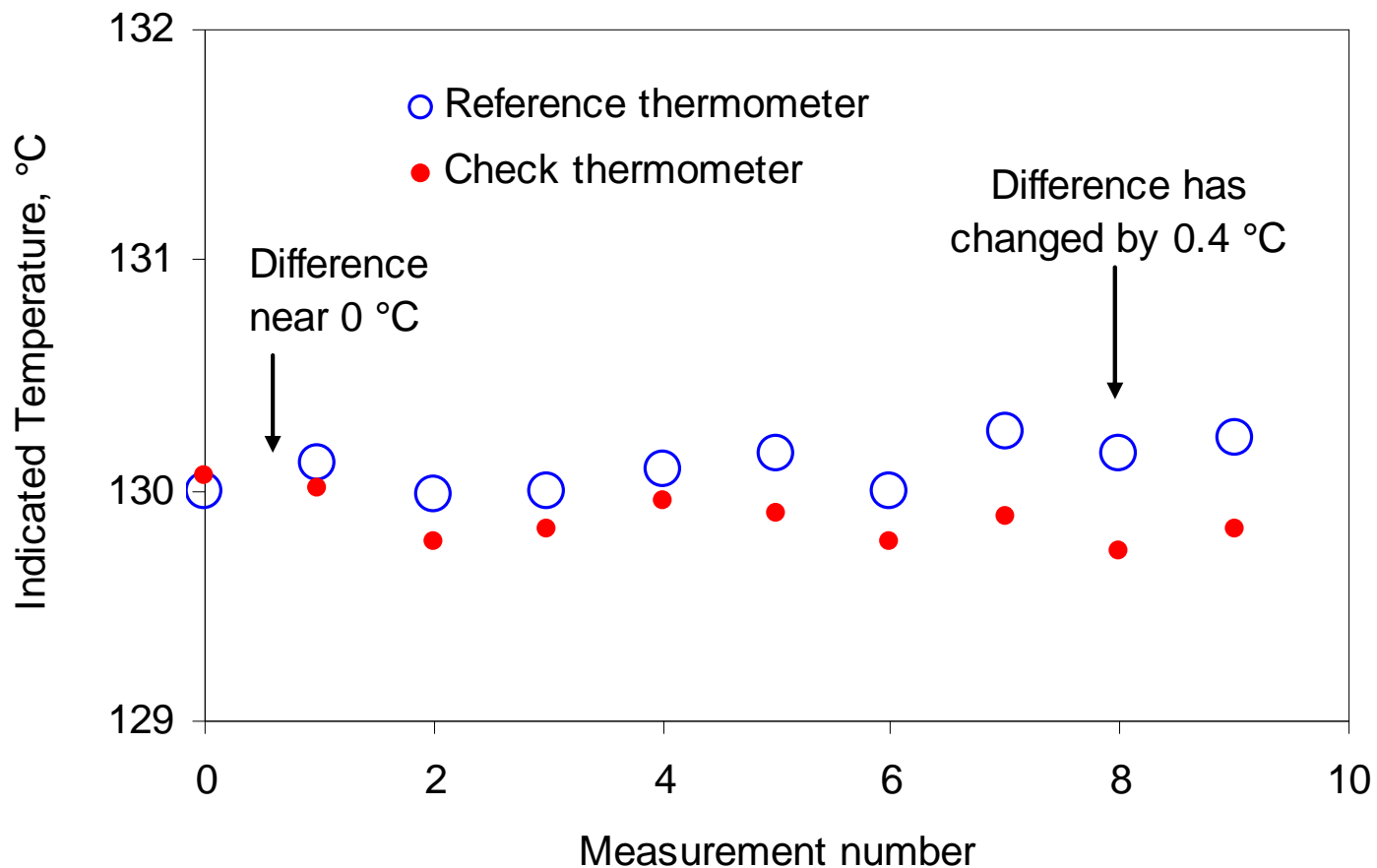

Measurement Assurance: Historical Data

This method is only useful if the instrument is not adjusted, or if the calibration laboratory supplies both “as received” and “as adjusted” data

Case 1: unadjusted instrument

Year	Reading at 150 °C
1999	150.00
2000	150.03
2001	150.02
2002	150.07
2003	150.06

Aver. drift: 0.016 °C/year

Maximum change of 0.05 °C/year

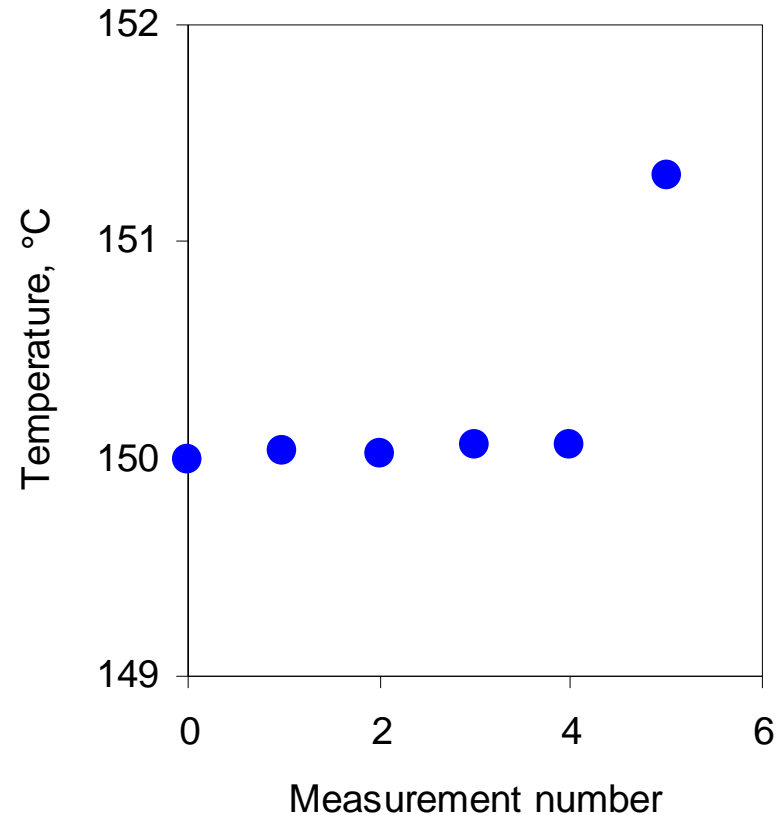

2004

151.30

Observed change of 0.24 °C—anomalous!

Measurement Assurance: Historical Data

Case 2: adjusted instrument

Year	As rec'vd.	As adjust.	Change from prev. year
1999	0.0	0.0	
2000	0.2	0.2	0.2
2001	0.5	0.0	0.3
2002	0.2	-0.1	0.2
2003	0.2	0.0	0.3



Aver. drift: 0.25 °C/year

Maximum drift of 0.3 °C/year

Conclusions

- Calibrations readily attainable to 0.1 °C uncertainty with proper choice of equipment
- Be sure to account for add uncertainties in use (drift, environmental effects) to calibration uncertainties
- Use of check standards or other measurement assurance tools is an important element of ensuring reliable results